



SX-BS-0622 Barcode Scanner

User Manual



Version: SX-BS-0622_UM_EN_V3.2.17

NOTICE



Ensure that the optional DC adapter works at +5 VDC, especially for the RS-232 interface cable.

1. All software, including firmware, furnished to the user is on a licensed basis.
2. The right is reserved to make changes to any software or product to improve reliability, function, or design.
3. The material in this manual is subject to change without notice. Please go to www.solux-tech.com for latest service information.
4. A standard packing includes a scanner, a PS2 cable and a CD (or a user manual). Accessories include a stand, a RS-232 cable, a 5 VDC adaptor and a USB cable.

Contents

NOTICE	i
Contents	iii
1 Specifications	1
1-1 Technical specifications	1
1-2 Default setting for each barcode	1
1-3 Decode zone	2
2 Get Started	3
2-1 Cable connector pin-outs descriptions	3
2-2 Dimensions	4
2-3 Parts of the scanner	5
2-4 Introduction to installation	6
2-4-1 Installation - keyboard wedge	6
2-4-2 Installation - RS-232	6
2-4-3 Installation - USB	7
2-4-5 Remove the interface cable	7
2-5 Scanning	8
2-6 Auto-detection	8
3 Parameter menus	9
3-1 Example: configure scanner	9
3-2 Operate the scanner by receiving command via UART	11
3-3 Interface selection	12
3-4 Keyboard wedge interface	13
3-5 RS-232 interface	17
3-6 USB interface	20
3-7 Scan mode & some global settings	23
3-8 Indication	27
3-9 Auto-detection setting	28
3-10 UPC-A	29
3-11 UPC-E	31
3-12 UPC-E1	33
3-13 EAN-13 (ISBN/ISSN)	35
3-14 EAN-8	38
3-15 Code 39 (Code 32, Trioptic Code 39)	40
3-16 Interleaved 2 of 5	43
3-17 Industrial 2 of 5 (Discrete 2 of 5)	45
3-18 Matrix 2 of 5	46
3-19 Codabar	48
3-20 Code 128	51
3-21 UCC/EAN 128	53
3-22 ISBT 128	55
3-23 Code 93	57
3-24 Code 11	59
3-25 MSI/Plessey	61
3-26 UK/Plessey	63
3-27 China Post	65
3-28 China Finance	67
3-29 Telepen	70
3-30 GS1 DataBar (GS1 DataBar Truncated)	72
3-31 GS1 DataBar Limited	73
3-32 GS1 DataBar Expanded	74
3-33 G1-G4 & C1-C2 & FN1 substitution string setting	76
3-34 G1-G4 string position & Code ID position	80
3-35 String transmission	81
4 Troubleshooting	84
5 Maintenance	85
6 Assembling the stand	86

7 Barcode representing non-printable character 87
8 ASCII Table 88
9 Test Chart 89
10 Return default parameters & Firmware version list 91
11 Configuration alphanumeric entry barcode 92

1 Specifications

1-1 Technical specifications

Table 1-1 Technical specifications

Dimensions	Height × Width × Depth: 8.2 cm × 6.7 cm × 16.8 cm	
Weight	168 g, without cable	
Cable	Straight 2.0 m	
Connector Type	RJ-45 phone jack connector	
Case Material	PC+TPU	
Programming Method	Manual (reading special barcode)	
Firmware Upgrade	Online	
Indicator	Beeper, LED	
Interface Supported	Keyboard wedge, RS-232, USB Keyboard, USB virtual COM	
Operating Mode	Hand-held, Auto-detection (optional)	
Input Voltage	5 VDC ± 0.25 V	
Power	500 mW (operating), 650 mW (maximum)	
Current	100 mA (operating), 130 mA (maximum)	
Standby Current	<250 µA	
Laser	645-660 nm laser diode	
Decoding Rate	200 times/sec	
Scanning Angle	±60°, ±65°, ±42° (skew, pitch, roll)	
Print Contrast	25% minimum reflection difference	
Decoding Capability	UPC-A, UPC-E, UPC-E1, EAN-13, EAN-8, ISBN (Bookland EAN), ISSN, Code 39, Code 39 full ASCII, Code 32, Trioptic Code 39, Interleaved 2 of 5, Industrial 2 of 5 (Discrete 2 of 5), Matrix 2 of 5, Codabar (NW7), Code 128, UCC/EAN 128, ISBT 128, Code 93, Code 11 (USD-8), MSI/Plessey, UK/Plessey, China Post, China Finance, GS1 DataBar (formerly RSS) variants, Telepen	
Decoding depth & Min. element width	(1 mil = 0.0254 mm) Long-Range series 5 mil: 40-110 mm 10 mil: 10-280 mm 13 mil: 15-315 mm 16 mil: 25-385 mm 35 mil: 145-630 mm	High-Density series 3 mil: 5-50 mm 10 mil: 10-85 mm 13 mil: 10-150 mm 16 mil: 25-165 mm 35 mil: 145-295 mm
Temperature	0° to 50°C (32° to 120°F), operating; -40° to 60°C (-40° to 140°F), storage	
Humidity	5% to 95% (non-condensing)	
Safety	Laser Safety: EN60825-1, Class 1 EMC: EN55022, EN55024 Electrical Safety: EN60950-1 Drop resistance: Multiple 4.0 m (13.1 ft.) drops to concrete Protection class: IP52	

1-2 Default setting for each barcode

Table 1-2 Default setting for each barcode

Code type	Read enable	Check digit verification	Check digit transmission	Min. code length	Proprietary code ID	AIM code ID
UPC-A	√	√	√	(12) ²	A]Em
UPC-E	√	√	√	(8) ²	D]Em
UPC-E1	√	√	√	(8) ²	D]Em
EAN-13	√	√	√	(13) ²	A]Em
EAN-8	√	√	√	(8) ²	C]Em
ISBN (Bookland EAN) / ISSN ¹	√	√	√	(13) ²	B]Em
Code 39	√	-	-	1	M]Am
Interleaved 2 of 5	√	-	-	6	I]Im
Industrial 2 of 5	-	-	-	4	H]Im
Matrix 2 of 5	√	-	-	6	X]Im
Codabar	√	-	-	4	N]Fm
Code 128	√	√	-	1	K]Cm
UCC/EAN 128	√	√	-	1	K]Cm
ISBT 128	√	√	-	1	K]Cm
Code 93	√	√	-	1	L]Gm
Code 11	-	√	-	4	V	-
MSI/Plessey	-	-	-	4	O]Mm
UK/Plessey	√	√	-	1	U]Mm
China Post	√	-	-	(11) ²	T]Im
China Finance	√	-	-	(10) ²	Y	-
Telepen	√	√	-	1	P]Em
GS1 DataBar	√	-	-	(16) ²	R]em
GS1 DataBar Truncated ³	√	-	-	(16) ²	R]em
GS1 DataBar Limited	√	-	-	(16) ²	R]em
GS1 DataBar Expanded	√	-	-	1	R]em

Note: ¹The settings for ISBN/ISSN and EAN-13 must be the same except the code ID.

² Fixed-length barcodes.

³The settings for GS1 DataBar Truncated and GS1 DataBar must be the same.

1-3 Decode zone

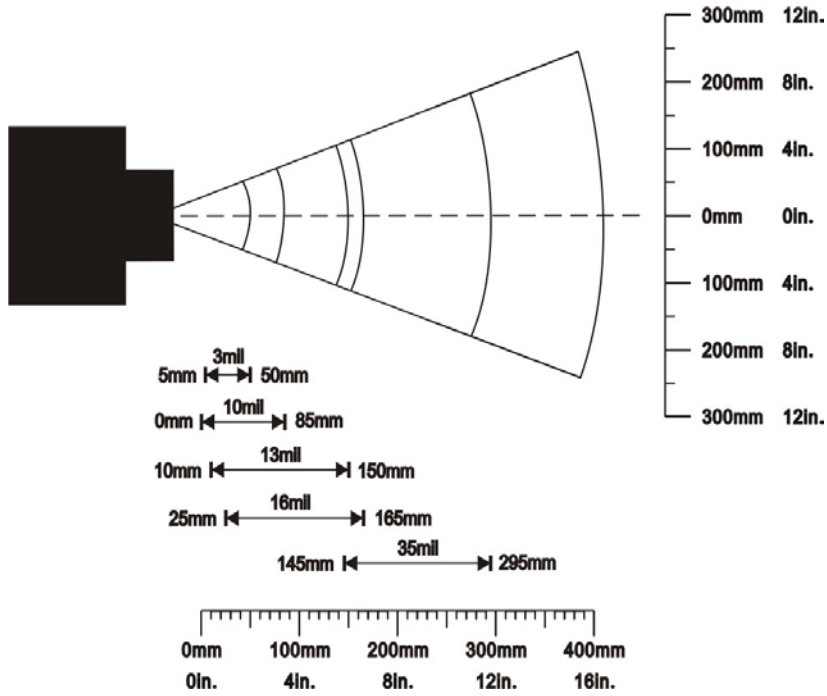

Figure 1-1 High-density series

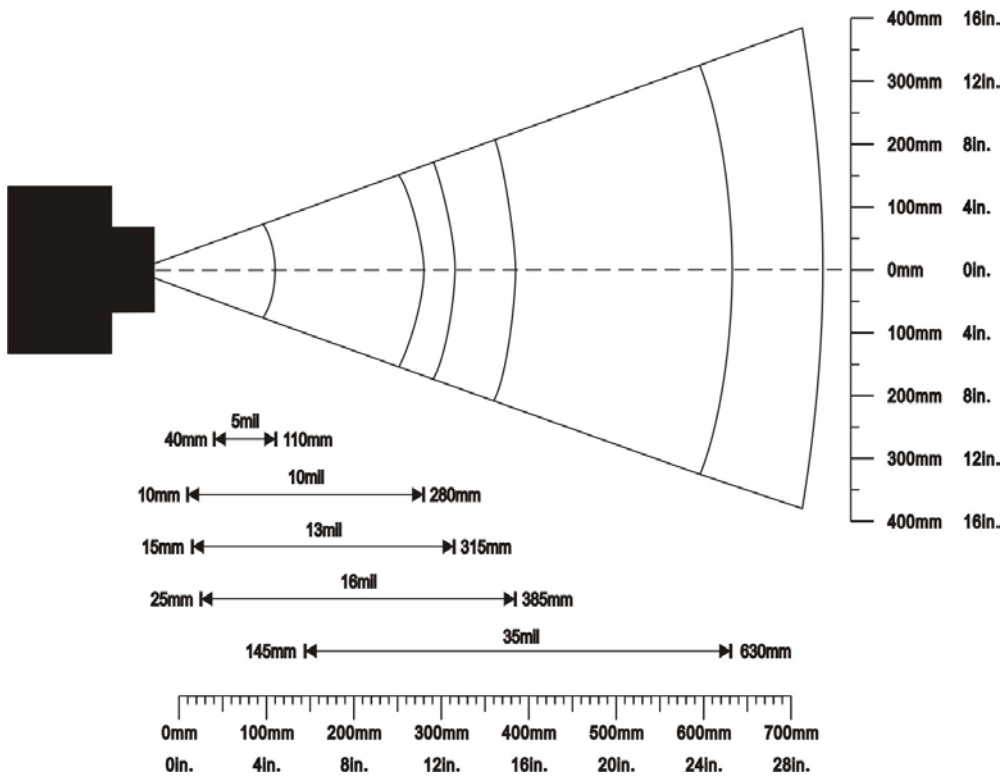

Figure 1-2 Long-range series

2 Get Started

2-1 Cable connector pin-outs descriptions

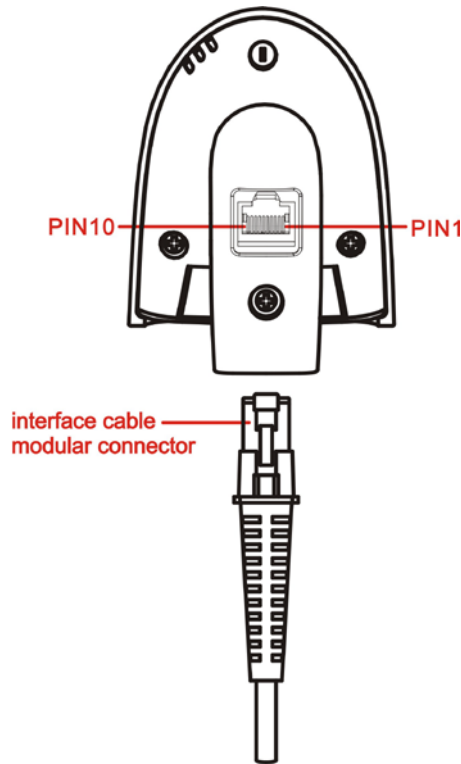

Figure 2-1 Cable connector interface pin-outs

The pin-outs descriptions in Table 2-1 apply to the cable connector on the scanner and are for reference only.

Table 2-1 Cable connector pin-outs descriptions

Pin	RS232	Keyboard (PS2)	USB
1	Power (+5V)	Power (+5V)	Power (+5V)
2	+3.3V (for interface auto selection purpose)	Ground (for interface auto selection purpose)	+3.3V (for interface auto selection purpose)
3	Ground	Ground	Ground
4	+3.3V (for interface auto selection purpose)	Reserved	Ground (for interface auto selection purpose)
5	TxD	KeyClock	Reserved
6	RxD	KeyData	Reserved
7	Reserved	TermClock	Reserved
8	Reserved	TermData	Reserved
9	CTS	Reserved	D-
10	RTS	Reserved	D+

Note: Voltage level of all RS232 Pin-outs (RxD, TxD, CTS and RTS) is 0V for logic low and 3.3V for logic high.

2-2 Dimensions

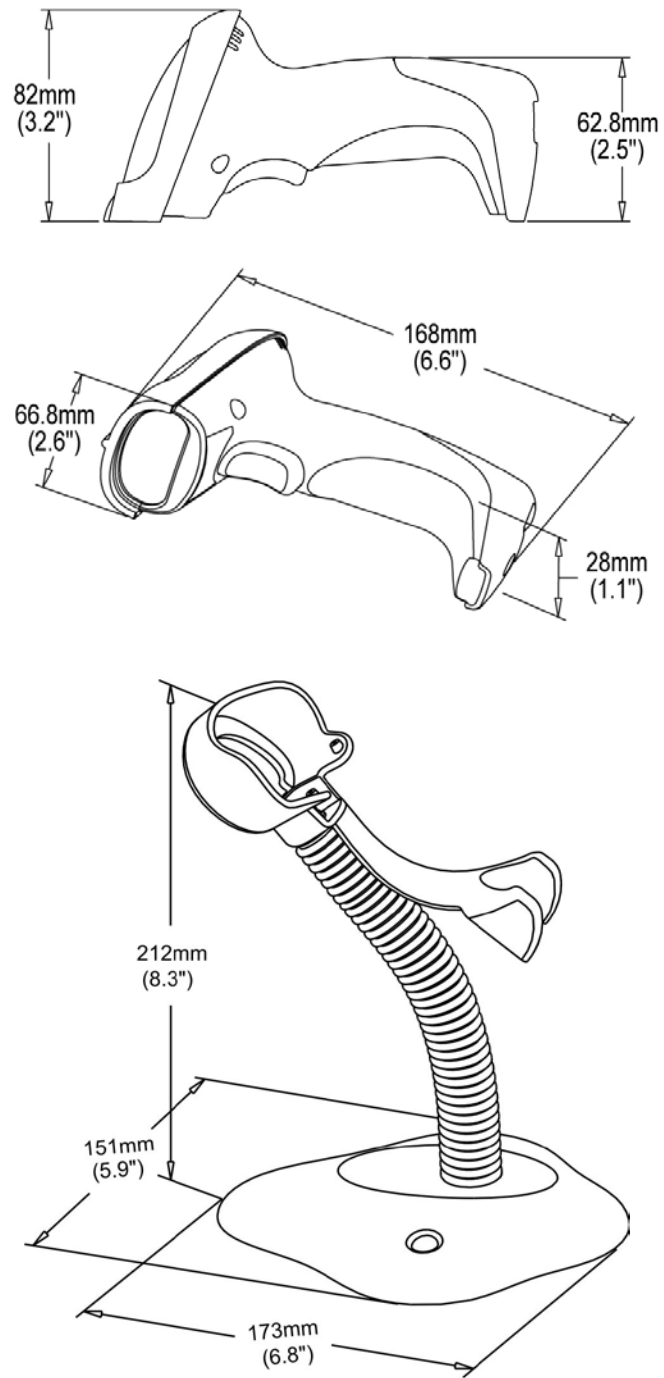

Figure 2-2 Dimensions of scanner

2-3 Parts of the scanner

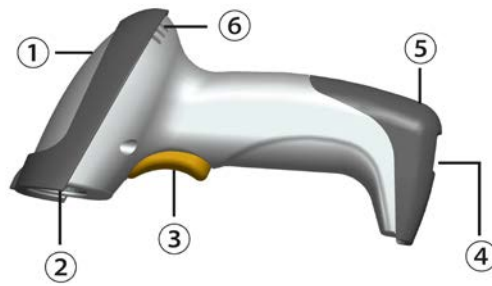

Figure 2-3

- ① LED
- ② Exit window
- ③ Trigger
- ④ Cable interface port
- ⑤ Release-hole of the cable
- ⑥ Beeper

2-4 Introduction to installation

Note: If any of the below operation is incorrect, turn off the power immediately and check the scanner for any improper connections. Go through all steps again.

2-4-1 Installation - keyboard wedge

1. Switch off the host and unplug the keyboard connector.
2. Attach the modular connector of the Y-cable to the cable interface port on the scanner.
3. Connect the round male DIN host connector of the Y-cable to the keyboard port on the host device.
4. Connect the round female DIN keyboard connector of the Y-cable to the keyboard.
5. Ensure that all connections are secure.
6. Switch on the host system.

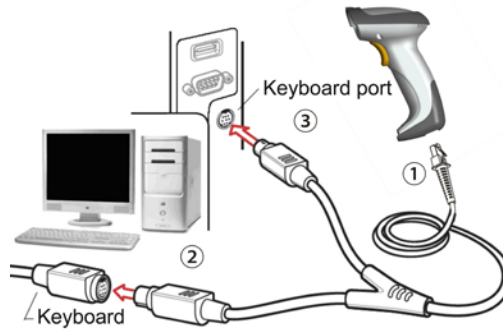

Figure 2-4

2-4-2 Installation - RS-232

1. Connect the RS-232 interface cable to the bottom of the scanner.
2. Connect the other end of the interface cable to the serial port on the host. Tighten the two screws to secure the connector to the port.
3. If the host does not have power supply (on PIN 9), connect the external power supply (DC adapter) to the RS-232 cable.



Figure 2-5

2-4-3 Installation - USB

The scanner attaches directly to a USB host, and is powered by it. No additional power supply is required.

1. Refer to Figure 7-3, connect the USB interface cable to the bottom of the scanner.
2. Plug the series A connector in the USB host, or an available port of the terminal.
3. Windows will automatically detect the USB device.

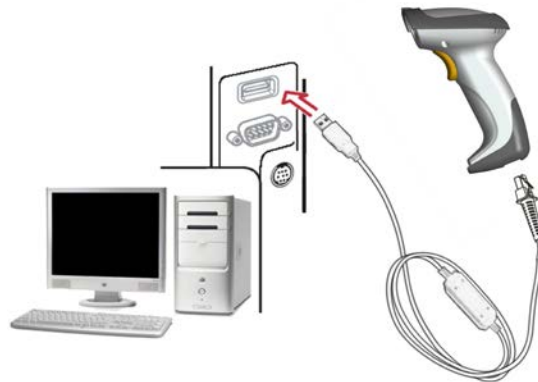

Figure 2-6

2-4-5 Remove the interface cable

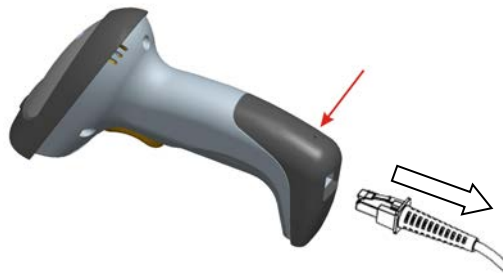

Figure 2-7

1. Find the release-hole.
2. Insert a thin wire into the hole and pull out the cable gently.

2-5 Scanning

The scanner has two scanning modes: hand-held and auto-detection. When the scanner is scanning, ensure the scan line crosses every bar and space of the symbol.



2-6 Auto-detection

The auto-detection scanning mode has two operating modes: in-stand and always ON. The following is an introduction to in-stand auto-detection mode.

1. When the scanner is seated in the stand, the scanner operates in auto-detection mode (see Figure 2-9). When scanner is removed from the stand, it operates in its normal hand-held mode.
2. To scan a bar code, present the bar code and ensure the scan line crosses every bar and space of the symbol.
3. Upon successful decode, the scanner beeps and the LED lights.
4. When the laser light is off, the present bar code must be removed to active next scanning.



Figure 2-9

3 Parameter menus

3-1 Example: configure scanner

Important notes:

1. After each successful programming, the scanner will beep twice.
2. Throughout the programming barcode menus, **the factory default settings are indicated with asterisks (*)**.
3. During the process of programming, LED is lighting to indicate the programming correctness. LED will go off if any incorrect programming operation performed.
4. After each successful programming, LED will go off and the scanner will beep twice.

Two programming modes have been provided as bellows:

① Single-scan setting

Scan the appropriate **Single-scan setting** (e.g. **%0101D00%**) according to the user's demand.

Example: to set **Flow control** to be XON/XOFF.

Steps: Scan the following barcode.



② Multiple-scan setting

The steps of configure scanner are:

1. Scan the **SETUP** bar code on the parameter setting part.
2. Enter the option mode by scanning the **Option bar code**.
3. To the right of the option barcode, the necessary alphanumeric inputs are listed. Scan these alphanumeric entries.
4. Scan the **END** bar code, listed on the lower right hand corner of each parameter setting part.
5. **Notes that only one parameter can be setup at each time.**

Example: to set **Flow control** to be XON/XOFF.

Steps: Scan the following barcodes in order.





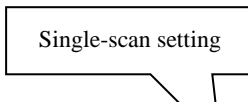

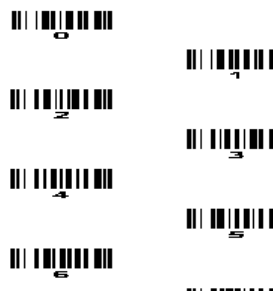

SETUP



Option bar code	Option	Alpha. entry	Single-scan setting
Flow control 0301	None	00*	 %0301D00%
	RTS/CTS (Host: Low RTS)	01	 %0301D01%



	RTS/CTS (Host: High RTS)	02	 %0301D02%
	XON/XOFF	03	 %0301D03%
	ACK/NAK	04	 %0301D04%
Inter-character delay  0302	0ms	00*	 %0302D00%
	5ms	01	 %0302D01%

Option bar code

%%%END END

END bar code

Alpha. entries

3-2 Operate the scanner by receiving command via UART

Note

- 1) The information in this chapter is provided for the scanner with RS232 cable or USB cable.
- 2) If the scanner is with USB cable, the setting of USB device type must be set as "USB virtual COM". Please refer to chapter of [3-6 USB interface](#).
- 3) Please read the chapter of [3-7 Scan mode & some global settings](#) about the setting of Scan mode in details.
- 4) UART parameter setting:
 - a) Baud rate: 9600 bps.
 - b) Data bits: 8 bits.
 - c) Stop bit: 1 bit.
 - d) Parity check bit: None.
 - e) Flow control: None.

Guide of control command: all commands are sent by UART

- 1) Start command: "0x54" (T)
When the scanner received the above command, it will start barcode scanning following the setting of Scanning mode. If the scanner is in the mode of "Auto-detection", the scanner will have a single scan, then returns to "Auto-detection" mode.
- 2) Stop command: "0x50" (P)
If the Scanning mode is set as "Alternate continue" or "Continue", and the scanner received the above command, it will stop barcode scanning and act as in an idle mode.
- 3) Restart command: "0x35" (R)
Once the scanner received the above command, it will restart.

Returning message from the scanner





- 1) A successful decode
Once the scanner successfully decoded a barcode, the scanner will stop scanning and returns the barcode data to the Host.
- 2) Not a successful decode
Once the scanner failed to decode a barcode before stopping scanning, the scanner will return a message to the Host. The message is set as "0x25, 0x25, 0x4E, 0x6F, 0x52, 0x65, 0x61, 0x64" (%%NoRead).

3-3 Interface selection

This scanner supports interfaces such as keyboard wedge, RS-232 serial wedge, and USB interface. In most of the cases, simply selecting an appropriate cable provided by the manufacturer will work for a specific interface.

Interface selection:

Auto detection-By setting this function, the scanner will automatically detect the keyboard wedge, RS-232 or USB interface for user.

Option bar code	Option	Alpha. entry	Single-scan setting
Interface selection  0101	Auto detection (Keyboard wedge /RS-232/USB)	00*	 %0101D00%
	Keyboard wedge	01	 %0101D01%
	RS-232	02	 %0101D02%
	USB	03	 %0101D03%

 %%%END END

3-4 Keyboard wedge interface

Keyboard type: As a keyboard interface, the scanner supports most of the popular PCs and IBM terminals.

Keyboard layout: The scanner supports different national keyboard layouts.

Clock period: According to the PS2 protocol, the clock is provided by the device, e.g. keyboard or scanner, with the period between 60us to 100us.

Delay-after-compound-key: In some rare occasions, machine with low speed PS2 communication port would require a free time gap following the press/release of the compound key (Shift, Ctrl or Alt).

Numeric key:

Alphabetic key- the scanner will output code result as alphabetic key.

Numeric key- the scanner will output code result as pressing numeric keypad ('0', '1', '2', '3', '4', '5', '6', '7', '8', '9', '.', '+', '-', '/', '*' only).

Alt+ keypad- the scanner will output code result as pressing Alt+ numeric key (on keypad). Note that the Num Lock control key must be ON. This setting can be specially adapted for use with different national keyboard layout.

Power-on simulation: All of the PCs check the keyboard status during power-on self test. It simulates keyboard timing and passes keyboard present status to the PC during power-on.

Inter-character delay: This delay is inserted after each data character transmitted.

Inter-byte delay: This delay is inserted after each byte transmitted. Normally a character is comprised of three or above bytes.

Block trans. delay: It is a delay timer between barcode data output. This feature is used to transfer continually with shorter barcode data.

Caps Lock reversion: By setting enable, the status of Caps Lock key (i.e. being pressed ON or OFF) on the keyboard is simulated in a reversion status.























Caps Lock override: If this function is enabled, on AT or AT notebook hosts, the keyboard ignores the state of the Caps Lock key. Therefore, an 'A' in the bar code is sent as an 'A' no matter what the state of the keyboard's Caps Lock key.

A guide of setting while the scanned data is incorrectly displayed on the host

- ✚ If some characters are missed or some additional characters are incorrectly displayed on the host, set the Inter-byte delay (0208) to be "01" or greater value.
- ✚ If some capital character (e.g. "A") or compound-key-characters (e.g. "shift+", "Ctrl+", "Alt+") are displayed incorrectly, set the Delay-after-compound-key to be "01" or greater value.
- ✚ If some digits are incorrectly displayed as some symbol characters (e.g. "1" and "2" are displayed incorrectly as "!" and "@"), set the Clock period (0203) to be greater value (e.g. 04, 05).





















%SETUP SETUP

Option bar code	Option	Alpha. entry	Single-scan setting
Keyboard type  0201	IBM AT, PS/2	00*	 %0201D00%
	Apple Mac compatibles	01	 %0201D01%
Keyboard layout  0202	USA	00*	 %0202D00%
	Turkish F	01	 %0202D01%
	Turkish Q	02	 %0202D02%
	French	03	 %0202D03%
	Italian	04	 %0202D04%
	Spanish	05	 %0202D05%
	Slovak	06	 %0202D06%
	Denmark	07	 %0202D07%
	Japanese	08	 %0202D08%
	German	09	 %0202D09%
	Belgian	10	 %0202D10%
	Russian	11	 %0202D11%
Clock period  0203	60us	00	 %0203D00%
	70us	01	 %0203D01%
	80us	02*	 %0203D02%
	90us	03	 %0203D03%
	100us	04	 %0203D04%
	200us	05	 %0203D05%









%SETUP SETUP

Option bar code	Option	Alpha. entry	Single-scan setting
Delay-after-compound-key  0204	0ms	00*	 %0204D00%
	10ms	01	 %0204D01%
	20ms	02	 %0204D02%
	40ms	03	 %0204D03%
	80ms	04	 %0204D04%
Numeric key  0205	Alphabetic key	00*	 %0205D00%
	Numeric keypad	01	 %0205D01%
	Alt+ keypad	02	 %0205D02%
Power-on simulation  0206	Disable	00*	 %0206D00%
	Enable	01	 %0206D01%
Inter-character delay  0207	0ms	00*	 %0207D00%
	5ms	01	 %0207D01%
	10ms	02	 %0207D02%
	20ms	03	 %0207D03%
	40ms	04	 %0207D04%
	80ms	05	 %0207D05%
Inter-byte delay  0208	1ms	00*	 %0208D00%
	2ms	01	 %0208D01%
	4ms	02	 %0208D02%
	8ms	03	 %0208D03%



%SETUP SETUP

Option bar code	Option	Alpha. entry	Single-scan setting
Caps Lock reversion  0209	Disable	00*	 %0209D00%
	Enable	01	 %0209D01%
Caps Lock override  0210	Disable	00*	 %0210D00%
	Enable	01	 %0210D01%



%%%END END

3-5 RS-232 interface

Host type:

Standard- The scanner is connected to a standard RS-232 interface.

OPOS/JPOS- The scanner is connected to a POS terminal which may be necessary to install the OPOS/JPOS driver to be compatible with the manufacturer's scanner. The OPOS/JPOS driver is provided by the scanner manufacturer; please contact the scanner manufacturer for the instruction.

Flow control:

None-The communication only uses TxD and RxD signals without any hardware or software handshaking protocol.

RTS/CTS-If the scanner wants to send the barcode data to host computer, it will issue the RTS signal first, wait for the CTS signal from the host computer, and then perform the normal data communication. If there is no replied CTS signal from the host computer after the timeout duration, the scanner will issue an error indication. By setting (Host idle: Low RTS) or (Host idle: High RTS), the scanner can be set to match the Serial Host RTS line.

XON/XOFF-An XOFF character turns the scanner transmission off until the scanner receives an XON character.

ACK/NAK-After transmitting data, the scanner expects either an ACK (acknowledge) or NAK (not acknowledge) response from the host. When a NAK is received, the scanner transmits the same data again and waits for either an ACK or NAK. After three unsuccessful attempts to send data when NAKs are received, the scanner issues an error indication and discards the data.

Inter-character delay: Refer to [Inter-character delay](#) of [3-4 Keyboard wedge interface](#).

















Response delay: This delay is used for serial communication of the scanner when it waits for a handshaking acknowledgment from the host.



%SETUP

SETUP

Option bar code	Option	Alpha. entry	Single-scan setting
Host type 0310	Standard	00*	 %0310D00%
	OPOS/JPOS	01	 %0310D01%
Flow control 0301	None	00*	 %0301D00%
	RTS/CTS (Host idle: Low RTS)	01	 %0301D01%
	RTS/CTS (Host idle: High RTS)	02	 %0301D02%
	XON/XOFF	03	 %0301D03%
	ACK/NAK	04	 %0301D04%
Inter-character delay 0302	0ms	00*	 %0302D00%
	5ms	01	 %0302D01%
	10ms	02	 %0302D02%
	20ms	03	 %0302D03%
	40ms	04	 %0302D04%
	80ms	05	 %0302D05%
Reserved 0303			
Response delay 0304	01-99 (100ms)	01-99	
		00*	 %0304D00%
Baud rate 0305	300	00	 %0305D00%
	600	01	 %0305D01%
	1200	02	 %0305D02%

	2400	03	 %0305D03%
	4800	04	 %0305D04%
	9600	05*	 %0305D05%
	19200	06	 %0305D06%
	38400	07	 %0305D07%
	57600	08	 %0305D08%
	115200	09	 %0305D09%
Parity  0306	None	00*	 %0306D00%
	Odd	01	 %0306D01%
	Even	02	 %0306D02%
Data bit  0307	8 bits	00*	 %0307D00%
	7 bits	01	 %0307D01%
Stop bit  0308	One bit	00*	 %0308D00%
	Two bits	01	 %0308D01%

 %%%END END

3-6 USB interface

USB device type:

HID keyboard– By setting, the scanner is used as a USB HID keyboard emulation device. The keyboard layout setting follows the setting of keyboard layout in the chapter of Keyboard wedge.

USB virtual COM– By setting, the scanner emulate a regular RS232-based COM port. If a Microsoft Windows PC is connected to the scanner, a driver is required to install on the connected PC. The driver will use the next available COM Port number. The driver and the installation guide can be found in the associated CD and on the manufacturer's website. A Windows-based software COM_Text is recommended to display the barcode data in text format. COM_Text emulates some kind of serial-key typing.

Note: When changing USB Device Types, the scanner automatically restarts.

HID for OPOS/JPOS- The scanner is connected to a POS terminal which may be necessary to install the OPOS/JPOS driver to be compatible with the manufacturer's scanner. The OPOS/JPOS driver is provided by the scanner manufacturer; please contact the scanner manufacturer for the instruction.

Keyboard layout: The scanner supports different national keyboard layouts.

Inter-character delay: This delay is inserted after each data character transmitted. By selecting, the user can change the output speed of the scanner to match the speed of the host USB communication port.

Numeric key:























Alphabetic key- the scanner will output code result as alphabetic key.

Numeric key- the scanner will output code result as pressing numeric keypad ('0', '1', '2', '3', '4', '5', '6', '7', '8', '9', '.', '+', '-', '/', '*' only).

Alt+ keypad- the scanner will output code result as pressing Alt+ numeric key (on keypad). Note that the Num Lock control key must be ON. This setting can be specially adapted for use with different national keyboard layout.



%SETUP SETUP

Option bar code	Option	Alpha. entry	Single-scan setting
USB device type  0901	HID keyboard	00*	 %0901D00%
	HID keyboard for Apple Mac	01	 %0901D01%
	USB virtual COM	02	 %0901D02%
	HID for OPOS/JPOS	03	 %0901D03%
Keyboard layout  0902	USA	00*	 %0902D00%
	Turkish F	01	 %0902D01%
	Turkish Q	02	 %0902D02%
	French	03	 %0902D03%
	Italian	04	 %0902D04%
	Spanish	05	 %0902D05%
	Slovak	06	 %0902D06%
	Denmark	07	 %0902D07%
	Japanese	08	 %0902D08%
	German	09	 %0902D09%
	Belgian	10	 %0902D10%
Russian	11	 %0902D11%	
Inter-character delay  0903	0ms	00	 %0903D00%
	5ms	01*	 %0903D01%
	10ms	02	 %0903D02%
	20ms	03	 %0903D03%



%SETUP SETUP

Option bar code	Option	Alpha. entry	Single-scan setting
	40ms	04	 %0903D04%
	60ms	05	 %0903D05%
Numeric key 0904	Alphabetic key	00*	 %0904D00%
	Numeric keypad	01	 %0904D01%
	Alt+ keypad	02	 %0904D02%



%%%END END

3-7 Scan mode & some global settings

Scan mode:

Good-read off-The trigger button must be pressed once to activate scanning. The light source of scanner stops scanning when there is a successful reading or no code is decoded after the Stand-by duration elapsed.

Momentary-The trigger button acts as a switch. Press button to activate scanning and release button to stop scanning. The light source of scanner stops scanning when there is a successful reading or no code is decoded after the Stand-by duration elapsed.

Alternate continue-The trigger button acts as a toggle switch. Press button to activate or stop scanning.

Continue-The scanner always keeps scanning, and it does not matter when the trigger button is pressed or duration is elapsed.

Timeout off-The trigger button must be pressed once to activate scanning. The light source of scanner stops scanning when no code is successful decoded after the Stand-by duration elapsed.

Same barcode delay time: If a barcode has been scanned and output once successfully, the laser beam must be off or moved away from the barcode beyond delay time to active scanning the same barcode. When this feature is set to be "0xFF", then the delay time is indefinite.

Double confirm: If it is enabled, the scanner will require a several times of same-decoded-data to confirm a valid reading.

Global Max./Min. code length: These two lengths are defined as the valid range of decoded barcode data length. Make sure that the minimum length setting is no greater than the maximum length setting, or otherwise the labels of the symbol will not be readable. In particular, the same value can be set for both minimum and maximum reading length to force the fixed length barcode decoded.

Notes:

1. Please set the max./min. length for individual barcode in later sections, if special demand is requested.

2. The number of check digits is included in max./min. code length.

3. These two settings have no effect on the symbols with fixed-length, e.g. UPC-A, UPC-E, EAN-13, EAN-8 and China Post.

Global G1-G4 string selection: The scanner offer one or two string group for all symbols. By setting one or two digits to indicate which string group you want to apply. You may refer to the chapters of [3-33 G1-G4 & C1-C2 & FN1 substitution string setting String setting](#) and [3-34 G1-G4 string position & Code ID position](#).

Example: Group 1 → set 01 or 10. Group 2 and 4 → set 24 or 42.

All valid settings include 00, 01, 02, 03, 04, 05, 06, 10, 11, 12, 13, 14, 15, 16, 20, 21, 22, 23, 24, 25, 26, 30, 31, 32, 33, 34, 35, 36, 40, 41, 42, 43 and 44.

Element amendment: If it is enabled, the scanner can read the barcode comprised with bars and spaces in different scale.

Character output restraint:

Printable character only- If this option is selected, the scanner will output the printable characters only, i.e. in ASCII from 20H to 7EH.

Alphanumeric character only- If this option is selected, the scanner will output the alphanumeric characters only, i.e. "A"- "Z", "a"- "z", "0"- "9".

Decoder optimization: If it is enabled, the scanner will optimize the decoder with error correction. This function is not effective for all types of barcode.

Data output delay in continue-scan mode: If it is enabled, in the continue-scan mode, the scanner can store the data while continue-scanning. The scanner will output the data after the predefined delay elapsed. The maximum storage of data is 1000 characters. If this parameter is set to be "00", the scanner will not store data. And if the parameter is set to be "FF", the scanner will output data after stopping scanning.

Enter sleeping-mode delay: The scanner will enter sleeping mode if the scanner has been in the idle mode after the predefined delay elapsed. The scanner will be awakened by pressing the trigger once.

















%SETUP SETUP

Option bar code	Option	Alpha. entry	Single-scan setting
Scan mode 0401	Good-read off	00	 %0401D00%
	Momentary	01*	 %0401D01%
	Alternate	02	 %0401D02%
	Continue	03	 %0401D03%
	Timeout off	04	 %0401D04%
Standby duration 0402	01-99 (second)	01-99	
		04*	 %0402D04%
Same barcode delay time 0403	00-FF ₁₆ (50ms)	00-FF ₁₆	
		00	 %0403H00%
		08*	 %0403H08%
Double confirm 0404	00-09 (00: no)	00-09	
		00*	 %0404D00%
Global max. code length 0405	04-99	04-99	
		99*	 %0405D99%
Global min. code length 0406	01-99	01-99	
		04*	 %0406D04%
Global G1-G4 string selection 0407	00-44	00-44	
		00*	 %0407D00%
Element amendment 0408	Disable	00	 %0408D00%
	Enable	01*	 %0408D01%



%SETUP SETUP

Option bar code	Option	Alpha. entry	Single-scan setting
Character output restraint  0409	None	00*	 %0409D00%
	Printable character only	01	 %0409D01%
	Alphanumeric character only	02	 %0409D02%
Decoder optimization  0410	Disable	00	 %0410D00%
	Enable	01*	 %0410D01%
Data output delay in continue-scan mode  0411	00-FF ₁₆ (100ms) FF (Never)	00-FF ₁₆	
		00*	 %0411D00%
Enter sleeping-mode delay  0412	15 min	00	 %0412D00%
	30 min	01*	 %0412D01%
	60 min	02	 %0412D02%
	Never	03	 %0412D03%
Reserved (Character encoding)  0413			



%%END END

3-8 Indication

Power on alert: After power-on the scanner will generate an alert signal to indicate a successful self-test.

LED indication: After each successful reading, the LED above the scanner will light up to indicate a good barcode reading.

Beeper indication: After each successful reading, the scanner will beep to indicate a good barcode reading, and its beep tone duration is adjustable.

Beep tone duration: This parameter can be adjusted for a good reading upon favorite usage.

Volume of beeper: This parameter can be adjusted for different level of the volume of the beeper.

 %SETUP SETUP			
Option bar code	Option	Alpha. entry	Single-scan setting
Power on alert  0501	Disable	00	 %0501D00%
	Enable	01*	 %0501D01%
LED indication  0502	Disable	00	 %0502D00%
	Enable	01*	 %0502D01%
Beeper indication  0503	Disable	00	 %0503D00%
	Enable	01*	 %0503D01%
Beep tone duration  0504	01-09 (10ms)	01-09	
		05*	 %0504D05%
Volume of beeper  0505	Low	00	 %0505D00%
	Middle	01	 %0505D01%
	High	02*	 %0505D02%
 %%%END END			

3-9 Auto-detection setting

Auto-detect sensor: By setting Enable, the scanner will start operating if any nearby object has been detected. The laser light of scanner stops scanning when there is a successful reading or no code is decoded after the Stand-by duration elapsed. Once the laser light stops scanning, the present object must be removed to enable Auto-detect sensor.

Operating mode:

In-stand-auto-detection- The scanner must be placed in the stand to enable Auto-detect sensor.

Auto-detection-always-ON- Auto-detect sensor is always enabled regardless of the placement of the scanner.

In-stand-continue- The scanner must be placed in the stand to enable the scanning mode to be set as continue.

Option bar code	Option	Alpha. entry	Single-scan setting
 %SETUP SETUP Auto-detect sensor  0601	Disable	00	 %0601D00%
	Enable	01*	 %0601D01%
Operation mode  0602	In-stand-auto-detection	00*	 %0602D00%
	Auto-detection-always-ON	01	 %0602D01%
	In-stand-continue	02	 %0603D02%
Stand-by duration  0603	01-99 (second)	01-99	
		04*	 %0603D04%

 %%%END END

3-10 UPC-A

Read: Format

System character	Data digits (10 digits)	Check digit (1 digit)
------------------	-------------------------	-----------------------

Check digit verification: The check digit verification is optional.

Check digit trans.: By setting Enable, check digit will be transmitted.

Code ID setting: Code ID is a one-or-two-character string used to represent the symbol upon a succeeding reading. If you want application to transmit Code ID, you must set **Code ID transmission** to be enabled. Refer to the chapter of [3-35 String transmission](#).

Insertion group selection: Refer to **Global insertion group selection** of the chapter of [3-7 Scan mode & some global settings](#).

Supplement digits: The Supplement digits barcode is the supplemental 2 or 5 characters.

Format

System character	Data digits (10 digits)	Check digit	Supplement digits 2 or 5
------------------	-------------------------	-------------	--------------------------

Truncation/Expansion:

Truncate leading zeros- The leading “0” digits of UPC-A data characters can be truncated when the feature is enabled.

Expand to EAN-13- It extends to 13-digits with a “0” leading digit when the feature is enabled.

Truncate system character- The system character of UPC-A data can be truncated when the feature is enabled.

Add country code- The country code (“0” for USA) can be added when the feature is enabled.

Option bar code	Option	Alpha. entry	Single-scan setting
 Read 1101	Disable	00	 %1101D00%
	Enable	01*	 %1101D01%
 Check digit verification 1102	Disable	00	 %1102D00%
	Enable	01*	 %1102D01%
 Check digit trans. 1103	Disable	00	 %1103D00%
	Enable	01*	 %1103D01%
 Code ID setting 1104	00-FF ₁₆ (ASCII)	00-FF ₁₆	
		<A>*	 %1104H41%
 Insert group selection 1105	00-44	00-44	
		00*	 %1105D00%
Supplement digits	None	00*	 %1106D00%



%SETUP SETUP

Option bar code	Option	Alpha. entry	Single-scan setting
 1106	2 digits	01	 %1106D01%
	5 digits	02	 %1106D02%
	2 or 5 digits	03	 %1106D03%
Truncation/Expansion  1107	None	00*	 %1107D00%
	Truncate leading zeros	01	 %1107D01%
	Expand to EAN-13	02	 %1107D02%
	Truncate system character	03	 %1107D03%
	Add country code	04	 %1107D04%
Reserved  1108			



%%END END

3-11 UPC-E

Read: Format

System character "0"	Data digits (6 digits)	Check digits (1 digit)
----------------------	------------------------	------------------------

Check digit verification: The check digit verification is optional and made as the sum of the numerical value of the data digits.

Check digit trans.: By setting Enable, check digit will be transmitted.

Code ID setting: Refer to [Code ID setting](#) of [3-10 UPC-A](#).

Insertion group selection: Refer to [Insertion group selection](#) of [3-10 UPC-A](#).

Supplement digits:

Format

System character "0"	Data digits (6 digits)	Check digit	Supplement digits 2 or 5
----------------------	------------------------	-------------	--------------------------

Truncation/Expansion:

Truncate leading zeros- Refer to [Truncation/Expansion](#) of [3-10 UPC-A](#).

Expand to EAN-13- It extends to 13-digits with "0" digits when the feature is set to be enabled.

Example: Barcode "0123654",

Output: "0012360000057".

Expand to UPC-A- It extends to 12-digits when the feature is set to be enabled.













Truncate system character- The system character "0" of UPC-E data can be truncated when the feature is enabled.

Add country code- The country code ("0" for USA) can be added when the feature is enabled.

Option bar code	Option	Alpha. entry	Single-scan setting
 Read 1201	Disable	00	 %1201D00%
	Enable	01*	 %1201D01%
 Check digit verification 1202	Disable	00	 %1202D00%
	Enable	01*	 %1202D01%
 Check digit trans. 1203	Disable	00	 %1203D00%
	Enable	01*	 %1203D01%
 Code ID setting 1204	00-FF ₁₆ (ASCII)	00-FF ₁₆	
		<D>*	 %1204H44%
 Insert group selection 1205	00-44	00-44	
		00*	 %1205D00%
Supplement digits	None	00*	 %1206D00% *



%SETUP SETUP

Option bar code	Option	Alpha. entry	Single-scan setting
 1206	2 digits	01	 %1206D01%
	5 digits	02	 %1206D02%
	2 or 5 digits	03	 %1206D03%
Truncation/Expansion  1207	None	00*	 %1207D00%
	Truncate leading zeros	01	 %1207D01%
	Expand to EAN-13	02	 %1207D02%
	Expand to UPC-A	03	 %1207D03%
	Truncate system character	04	 %1207D04%
	Add country code	05	 %1207D05%
Reserved  1208			



%%END END

3-12 UPC-E1

Read: Format

System character "1"	Data digits (6 digits)	Check digits (1 digit)
----------------------	------------------------	------------------------

Check digit verification: The check digit is optional and made as the sum of the numerical value of the data digits.

Check digit trans.: By setting Enable, check digit will be transmitted.

Code ID setting: Refer to [Code ID setting](#) of [3-10 UPC-A](#).

Insertion group selection: Refer to [Insertion group selection](#) of [3-10 UPC-A](#).

Supplement digits:

Format

System character "1"	Data digits (6 digits)	Check digit	Supplement digits 2 or 5
----------------------	------------------------	-------------	--------------------------

Truncation/Expansion:

Expand to EAN-13- It extends to 13-digits with "0" digits when the feature is set to be enabled.

Expand to UPC-A- It extends to 12-digits when the feature is set to be enabled.

Truncate system character- The system character "1" of UPC-E1 data can be truncated when the feature is enabled.

Add country code- The country code ("0" for USA) can be added when the feature is enabled.

Option bar code	Option	Alpha. entry	Single-scan setting
 Read 3401	Disable	00	 %3401D00%
	Enable	01*	 %3401D01%
 Check digit verification 3402	Disable	00	 %3402D00%
	Enable	01*	 %3402D01%
 Check digit trans. 3403	Disable	00	 %3403D00%
	Enable	01*	 %3403D01%
 Code ID setting 3404	00-FF ₁₆ (ASCII)	00-FF ₁₆	
		<D>*	 %3404H44%
 Insert group selection 3405	00-44	00-44	
		00*	 %3405D00%
Supplement digits	None	00*	 %3406D00%



%SETUP SETUP

Option bar code	Option	Alpha. entry	Single-scan setting
 3406	2 digits	01	 %3406D01%
	5 digits	02 03	 %3406D02%
	2 or 5 digits		 %3406D03%
Truncation/Expansion  3407	None	00*	 %3407D00%
	Reserved	01	
	Expand to EAN-13	02	 %3407D02%
	Expand to UPC-A	03	 %3407D03%
	Truncate system character	04	 %3407D04%
	Add country code	05	 %3407D05%
Reserved  3408			



%%%END END

3-13 EAN-13 (ISBN/ISSN)

Read:

Format

Data digits (12 digits)	Check digit (1 digit)
-------------------------	-----------------------

Check digit verification: The check digit is optional and made as the sum of the numerical value of the data digits.

Check digit transmission: By setting Enable, check digit will be transmitted.

EAN-13 code ID setting: Refer to [Code ID setting](#) of [3-10 UPC-A](#).

Insertion group selection: Refer to [Insertion group selection](#) of [3-10 UPC-A](#).

Supplement digits:

Format

Data digits (12 digits)	Check digit	Supplement digits 2 or 5
-------------------------	-------------	--------------------------

ISBN/ISSN conversion: The ISBN (International Standard Book Number, or Bookland EAN) and ISSN (International Standard Serial Number) are two kinds of barcode for books and magazines. The ISBN is 10 digits with leading "978" and the ISSN is 8 digits with leading "977" of the EAN-13 symbol.

Example:

Barcode "9780194315104", Output: "019431510X".

Barcode "9771005180004", Output: "10051805".

ISBN/ISSN code ID setting: Refer to [Code ID setting](#) of [3-10 UPC-A](#).





%SETUP

SETUP

Option bar code	Option	Alpha. entry	Single-scan setting
Read 1301	Disable	00	 %1301D00%
	Enable	01*	 %1301D01%
Check digit verification 1302	Disable	00	 %1302D00%
	Enable	01*	 %1302D01%
Check digit transmission 1303	Disable	00	 %1303D00%
	Enable	01*	 %1303D01%
EAN-13 code ID setting 1304	00-FF ₁₆ (ASCII)	00-FF ₁₆	
		<A>*	 %1304H41%
Insert group selection 1305	00-44	00-44	
		00*	 %1305D00%
Supplement digits 1306	None	00*	 %1306D00%
	2 digits	01	 %1306D01%
	5 digits	02	 %1306D02%
	2 or 5 digits	03	 %1306D03%
ISBN/ISSN conversion 1307	Disable	00*	 %1307D00%



%SETUP SETUP

Option bar code	Option	Alpha. entry	Single-scan setting
	Enable	01	 %1307D01%
ISBN/ISSN code ID setting  1309	00-FF ₁₆ (ASCII)	00-FF ₁₆	
		*	 %1309H42%



%%%END END

3-14 EAN-8

Read:

Format

Data digits (7 digits)	Check digit (1 digit)
------------------------	-----------------------

Check digit verification: The check digit is optional and made as the sum of the numerical value of the data digits.

Check digit trans.: By setting Enable, check digit will be transmitted.

Code ID setting: Refer to [Code ID setting](#) of [3-10 UPC-A](#).

Insertion group selection: Refer to [Insertion group selection](#) of [3-10 UPC-A](#).

Supplement digits:

Format

Data digits (7 digits)	Check digit	Supplement Digits 2 or 5
------------------------	-------------	--------------------------

Truncation/Expansion: Refer to [Truncation/Expansion](#) of [3-10 UPC-A](#).



%SETUP SETUP

Option bar code	Option	Alpha. entry	Single-scan setting
Read 1401	Disable	00	
	Enable	01*	
Check digit verification 1402	Disable	00	
	Enable	01*	
Check digit trans. 1403	Disable	00	
	Enable	01*	
Code ID setting 1404	00-FF ₁₆ (ASCII)	00-FF ₁₆	
		<C>*	
Insert group selection 1405	00-44	00-44	
		00*	
Supplement digits 1406	None	00*	
	2 digits	01	
	5 digits	02	



%SETUP SETUP

Option bar code	Option	Alpha. entry	Single-scan setting
	2 or 5 digits	03	 %1406D03%
Truncation/Expansion 1407	None	00*	 %1407D00%
	Truncate leading zero	01	 %1407D01%
	Expand to EAN-13	02	 %1407D02%
Reserved 1408			



%%%END END

3-15 Code 39 (Code 32, Trioptic Code 39)

Read:

Format

Start character (*)	Data digits (variable)	Check digit (optional)	End character (*)
---------------------	------------------------	------------------------	-------------------

Check digit verification: The check digit is optional and made as the sum module 43 of the numerical value of the data digits.

Check digit transmission: By setting Enable, check digit will be transmitted.

Max./Min. code length: Each symbol has own max./min. code length. If both setting of max./min. code length are "00"s, the setting of global max./min. code length is effective. The length is defined as to the actual barcode data length to be sent. Label with length exceeds these limits will be rejected. Make sure that the minimum length setting is no greater than the maximum length setting, or otherwise all the labels of the symbol will not be readable. In particular, you can see the same value for both minimum and maximum reading length to force the fixed length barcode decoded.

Code ID setting: Refer to [Code ID setting](#) of [3-10 UPC-A](#).

Insertion group selection: Refer to [Insertion group selection](#) of [3-10 UPC-A](#).

Start/End transmission: The start and end characters of Code 39 are "*" s. You can transmit all data digits including two "*" s.

"*" as data character: By setting Enable, "*" can be recognized as data character.

Convert Code 39 to Code 32: Code 32 is a variant of Code 39 used by the Italian pharmaceutical industry. Note that Code 39 must be enabled in order for this parameter to function.

Format of Code 32

"A" (optional)	Data digits (8 digits)	Check digit (1 digit)
----------------	------------------------	-----------------------

Code 32 Prefix "A" transmission: By setting Enable, the prefix character "A" can be added to all Code 32 barcodes.

Trioptic Code 39 read: Trioptic Code 39 is a variant of Code 39 used in the marking of magnetic tapes and computer cartridges. Trioptic Code 39 symbols always contain six characters.

Format

Start character (\$)	Data digits (6 digits)	Eed character (\$)
----------------------	------------------------	--------------------

Trioptic Code 39 Start/End transmission: The start and end characters of Trioptic Code 39 are "\$" s. You can transmit all data digits including two "\$" s.















%SETUP SETUP

Option bar code	Option	Alpha. entry	Single-scan setting
Read 1501	Disable	00	 %1501D00%
	Enable	01*	 %1501D01%
Check digit verification 1502	Disable	00*	 %1502D00%
	Enable	01	 %1502D01%
Check digit transmission 1503	Disable	00*	 %1503D00%
	Enable	01	 %1503D01%
Max. code length 1504	00-99	00-99	
		00*	 %1504D00%
Min. code length 1505	00-99	00-99	
		01*	 %1505D01%
Code ID setting 1506	00-FF ₁₆ (ASCII)	00-FF ₁₆	
		<M>*	 %1506H4D%
Insert group selection 1507	00-44	00-44	
		00*	 %1507D00%
Format 1508	Standard	00*	 %1508D00%
	Full ASCII	01	 %1508D01%
Start/End transmission 1509	Disable	00*	 %1509D00%
	Enable	01	 %1509D01%
“*” as data character 1510	Disable	00*	 %1510D00%
	Enable	01	 %1510D01%



%SETUP SETUP

Option bar code	Option	Alpha. entry	Single-scan setting
Convert Code 39 to Code 32  1511	Disable	00*	 %1511D00%
	Enable	01	 %1511D01%
Code 32 Prefix "A" transmission  1512	Disable	00*	 %1512D00%
	Enable	01	 %1512D01%
Trioptic Code 39 read  1513	Disable	00*	 %1513D00%
	Enable	01	 %1513D01%
Trioptic Code 39 Start/End transmission  1514	Disable	00*	 %1514D00%
	Enable	01	 %1514D01%



%%%END END

Note 1: If Trioptic Code 39 is set Enable, Code 39 is forced Enable.
 Note 2: If Code 39 is set Disable, Trioptic Code 39 is forced Disable.

3-16 Interleaved 2 of 5

Read:

Format

Data digits (Variable)	Check digit (optional)
------------------------	------------------------

Check digit verification: The check digit is made as the sum module 10 of the numerical values of all data digits. There are two optional check digit algorithms: the specified Uniform Symbol Specification (USS) and the Optical Product Code Council (OPCC).

Check digit transmission: By setting Enable, check digit will be transmitted.

Max./Min. code length: Refer to [Max./Min. code length](#) of [3-15 Code 39 \(Code 32, Trioptic Code 39\)](#).

Code ID setting: Refer to [Code ID setting](#) of [3-10 UPC-A](#).

Insertion group selection: Refer to [Insertion group selection](#) of [3-10 UPC-A](#).



%SETUP SETUP

Option bar code	Option	Alpha. entry	Single-scan setting
Read 1601	Disable	00	 %1601D00%
	Enable	01*	 %1601D01%
Check digit verification 1602	Disable	00*	 %1602D00%
	USS	01	 %1602D01%
	OPCC	02	 %1602D02%
Check digit transmission 1603	Disable	00*	 %1603D00%
	Enable	01	 %1603D01%
Max. code length 1604	00-99	00-99	
		99	 %1604D99%
		00*	 %1604D00%
Min. code length 1605	00-99	00-99	
		06*	 %1605D06%
Code ID setting 1606	00-FF ₁₆ (ASCII)	00-FF ₁₆	
		<I>*	 %1606H49%
Insert group selection 1607	00-44	00-44	
		00*	 %1607D00%
Reserved 1608			



%%END END

3-17 Industrial 2 of 5 (Discrete 2 of 5)

Read:

Format

Data digits (variable)

Max./Min. code length: Refer to of *3-15 Code 39 (Code 32, Trioptic Code 39)*.

Code ID setting: Refer to of *3-10 UPC-A*.

Insertion group selection: Refer to of *3-10 UPC-A*.



%SETUP SETUP

Option bar code	Option	Alpha. entry	Single-scan setting
Read 1701	Disable	00*	
	Enable	01	
Max. code length 1702	00-99	00-99	
		99	
		00*	
Min. code length 1703	00-99	00-99	
		00*	
Code ID setting 1704	00-FF ₁₆ (ASCII)	00-FF ₁₆	
		<H>*	
Insert group selection 1705	00-44	00-44	
		00*	
Reserved 1706			



%%END END

3-18 Matrix 2 of 5

Read:

Format

Data digits (variable)	Check digit (optional)
------------------------	------------------------

Check digit verification: The check digit is made as the sum module 10 of the numerical values of all data digits.

Check digit transmission: By setting Enable, check digit will be transmitted.

Max./Min. code length: Refer to [Max./Min. code length](#) of [3-15 Code 39 \(Code 32, Trioptic Code 39\)](#).

Code ID setting: Refer to [Code ID setting](#) of [3-10 UPC-A](#).

Insertion group selection: Refer to [Insertion group selection](#) of [3-10 UPC-A](#).



%SETUP SETUP

Option bar code	Option	Alpha. entry	Single-scan setting
Read 1801	Disable	00	 %1801D00%
	Enable	01*	 %1801D01%
Check digit verification 1802	Disable	00*	 %1802D00%
	Enable	01	 %1802D01%
Check digit transmission 1803	Disable	00*	 %1803D00%
	Enable	01	 %1803D01%
Max. code length 1804	00-99	00-99	
		99	 %1804D99%
		00*	 %1804D00%
Min. code length 1805	00-99	00-99	
		06*	 %1805D06%
Code ID setting 1806	00-FF ₁₆ (ASCII)	00-FF ₁₆	
		<X>*	 %1806H58%
Insert group selection 1807	00-44	00-44	
		00*	 %1807D00%
Reserved 1808			



%%%END END

3-19 Codabar

Read:

Format

Start	Data digits (variable)	Check digit (optional)	End
-------	------------------------	------------------------	-----

Check digit verification: The check digit is made as the sum module 16 of the numerical values of all data digits.

Check digit transmission: By setting Enable, check digit will be transmitted.

Max./Min. code length: Refer to [Max./Min. code length](#) of [3-15 Code 39 \(Code 32, Trioptic Code 39\)](#).

Code ID setting: Refer to [Code ID setting](#) of [3-10 UPC-A](#).

Insertion group selection: Refer to [Insertion group selection](#) of [3-10 UPC-A](#).



Start/End type: Codabar has four pairs of Start/End pattern; you may select one pair to match your application.

Start/End transmission: Refer to [Start/End transmission](#) of [3-15 Code 39 \(Code 32, Trioptic Code 39\)](#).

Start/End character equality: By setting Enable, the start and end character of a Codabar barcode must be the same.



%SETUP SETUP

Option bar code	Option	Alpha. entry	Single-scan setting
Read  1901	Disable	00	 %1901D00%
	Enable	01*	 %1901D01%
Check digit verification  1902	Disable	00*	 %1902D00%
	Enable	01	 %1902D01%
Check digit transmission  1903	Disable	00*	 %1903D00%
	Enable	01	 %1903D01%
Max. code length  1904	00-99	00-99	
		99	 %1904D99%
		00*	 %1904D00%
Min. code length  1905	00-99	00-99	
		04	 %1905D04%
		00*	 %1905D00%
Code ID setting  1906	00-FF ₁₆ (ASCII)	00-FF ₁₆	
		<N>*	 %1906H4E%
Insert group selection  1907	00-44	00-44	
		00*	 %1907D00%
Start/End type  1908	ABCD/ABCD	00*	 %1908D00%
	abcd/abcd	01	 %1908D01%
	ABCD/TN*E	02	 %1908D02%



%SETUP SETUP

Option bar code	Option	Alpha. entry	Single-scan setting
	abcd/tn*e	03	 %1908D03%
Start/End transmission 1909	Disable	00*	 %1909D00%
	Enable	01	 %1909D01%
Start/End character equality 1910	Disable	00*	 %1910D00%
	Enable	01	 %1910D01%



%%%END END

3-20 Code 128

Read:

Format

Data digits (variable)	Check digit (optional)
------------------------	------------------------

Check digit verification: The check digit is made as the sum module 103 of all data digits.

Check digit transmission: By setting Enable, check digit will be transmitted.

Max./Min. code length: Refer to [Max./Min. code length](#) of [3-15 Code 39 \(Code 32, Trioptic Code 39\)](#).

Code ID setting: Refer to [Code ID setting](#) of [3-10 UPC-A](#).

Insertion group selection: Refer to [Insertion group selection](#) of [3-10 UPC-A](#).

Truncate leading zeros: The leading "0" digits of Code 128 barcode characters can be truncated when the feature is enabled.



%SETUP SETUP

Option bar code	Option	Alpha. entry	Single-scan setting
Read  2001	Disable	00	 %2001D00%
	Enable	01*	 %2001D01%
Check digit verification  2002	Disable	00	 %2002D00%
	Enable	01*	 %2002D01%
Check digit transmission  2003	Disable	00*	 %2003D00%
	Reserved	01	 %2003D01%
Max. code length  2004	00-99	00-99	
		99	 %2004D99%
		00*	 %2004D00%
Min. code length  2005	00-99	00-99	
		01*	 %2005D01%
Code ID setting  2006	00-FF ₁₆ (ASCII)	00-FF ₁₆	
		<K>*	 %2006H4B%
Insert group selection  2007	00-44	00-44	
		00*	 %2007D00%
Truncate leading zeros  2008	Disable	00*	 %2008D00%
	All leading "0"s	01	 %2008D01%
	Only the first "0"	02	 %2008D02%



%%%END

3-21 UCC/EAN 128

Read:

Format

Data digits (variable)	Check digit (optional)
------------------------	------------------------

Check digit verification: The check digit is made as the sum module 103 of all data digits.

Check digit transmission: By setting Enable, check digit will be transmitted.

Max. /Min. code length: Refer to [Max./Min. code length](#) of [3-15 Code 39 \(Code 32, Trioptic Code 39\)](#).

Code ID setting: Refer to [Code ID setting](#) of [3-10 UPC-A](#).

Insertion group selection: Refer to [Insertion group selection](#) of [3-10 UPC-A](#).

Truncate leading zeros: Refer to [Truncate leading zeros](#) of [8-21 Code 128](#).



%SETUP SETUP

Option bar code	Option	Alpha. entry	Single-scan setting
Read 2501	Disable	00	 %2501D00%
	Enable	01*	 %2501D01%
Check digit verification 2502	Disable	00	 %2502D00%
	Enable	01*	 %2502D01%
Check digit transmission 2503	Disable	00*	 %2503D00%
	Reserved	01	 %2503D01%
Max. code length 2504	00-99	00-99	
		00*	 %2504D00%
Min. code length 2505	00-99	00-99	
		01*	 %2505D01%
Code ID setting 2506	00-FF ₁₆ (ASCII)	00-FF ₁₆	
		<K>*	 %2506H4B%
Insert group selection 2507	00-44	00-44	
		00*	 %2507D00%
Truncate leading zeros 2508	Disable	00*	 %2508D00%
	All leading "0"s	01	 %2508D01%
	Only the first "0"	02	 %2508D02%



%%END END

3-22 ISBT 128

Read:

Format

Start character (“=” or “&”)	Data digits (variable)	Check digit (optional)
------------------------------	------------------------	------------------------

Check digit verification: The check digit is made as the sum module 103 of all data digits.

Check digit transmission: By setting Enable, check digit will be transmitted.

Max./Min. code length: Refer to [Max./Min. code length](#) of [3-15 Code 39 \(Code 32, Trioptic Code 39\)](#).

Code ID setting: Refer to [Code ID setting](#) of [3-10 UPC-A](#).

Insertion group selection: Refer to [Insertion group selection](#) of [3-10 UPC-A](#).



%SETUP SETUP

Option bar code	Option	Alpha. entry	Single-scan setting
Read 3301	Disable	00	 %3301D00%
	Enable	01*	 %3301D01%
Check digit verification 3302	Disable	00	 %3302D00%
	Enable	01*	 %3302D01%
Check digit transmission 3303	Disable	00*	 %3303D00%
	Reserved	01	 %3303D01%
Max. code length 3304	00-99	00-99	
		00*	 %3304D99%
Min. code length 3305	00-99	00-99	
		01*	 %3305D01%
Code ID setting 3306	00-FF ₁₆ (ASCII)	00-FF ₁₆	
		<K>*	 %3306H4B%
Insert group selection 3307	00-44	00-44	
		00*	 %3307D00%
Reserved 3308			



%%END END

3-23 Code 93

Read:

Format

Data digits (variable)	2 check digits (optional)
------------------------	---------------------------

Check digit verification: The check digit is made as the sum module 47 of the numerical values of all data digits.

Check digit transmission: By setting Enable, check digit will be transmitted.

Max./Min. code length: Refer to [Max./Min. code length](#) of [3-15 Code 39 \(Code 32, Trioptic Code 39\)](#).

Code ID setting: Refer to [Code ID setting](#) of [3-10 UPC-A](#).

Insertion group selection: Refer to [Insertion group selection](#) of [3-10 UPC-A](#).



%SETUP SETUP

Option bar code	Option	Alpha. entry	Single-scan setting
Read 2101	Disable	00	 %2101D00%
	Enable	01*	 %2101D01%
Check digit verification 2102	Disable	00	 %2102D00%
	Enable	01*	 %2102D01%
Check digit transmission 2103	Disable	00*	 %2103D00%
	Enable	01	 %2103D01%
Max. code length 2104	00-99	00-99	
		00*	 %2104D00%
Min. code length 2105	00-99	00-99	
		01*	 %2105D01%
Code ID setting 2106	00-FF ₁₆ (ASCII)	00-FF ₁₆	
		<L>*	 %2106H4C%
Insert group selection 2107	00-44	00-44	
		00*	 %2107D00%
Reserved 2108			



%%%END END

3-24 Code 11

Read:

Format

Data digits (variable)	Check digit 1 (optional)	Check digit 2 (optional)
------------------------	--------------------------	--------------------------

Check digit verification: The check digit is presented as the sum module 11 of all data digits.

Check digit transmission: By setting Enable, check digit 1 and check digit 2 will be transmitted upon your selected check digit verification method.

Max./Min. code length: Refer to [Max./Min. code length](#) of [3-15 Code 39 \(Code 32, Trioptic Code 39\)](#).

Code ID setting: Refer to [Code ID setting](#) of [3-10 UPC-A](#).

Insertion group selection: Refer to [Insertion group selection](#) of [3-10 UPC-A](#).



%SETUP SETUP

Option bar code	Option	Alpha. entry	Single-scan setting
Read 2201	Disable	00*	 %2201D00%
	Enable	01	 %2201D01%
Check digit verification 2202	Disable	00	 %2202D00%
	One digit	01*	 %2202D01%
	Reserved	02	
	Reserved	03	
Check digit transmission 2203	Disable	00*	 %2203D00%
	Enable	01	 %2203D01%
Max. code length 2204	00-99	00-99	
		00*	 %2204D00%
Min. code length 2205	00-99	00-99	
		00*	 %2205D00%
Code ID setting 2206	00-FF ₁₆ (ASCII)	00-FF ₁₆	
		<V>*	 %2206H56%
Insert group selection 2207	00-44	00-44	
		00*	 %2207D00%
Reserved 2208			



%%%END END

3-25 MSI/Plessey

Read:

Format

Data digits (variable)	Check digit 1 (optional)	Check digit 2 (optional)
------------------------	--------------------------	--------------------------

Check digit verification: The MSI/Plessey has one or two optional check digits. There are three methods of verifying check digits, i.e. Mod 10, Mod 10/10 and Mod 10/11. The check digit 1 and check digit 2 will be calculated as the sum module 10 or 11 of the data digits.

Check digit transmission: By setting Enable, check digit 1 and check digit 2 will be transmitted upon your selected check digit verification method.

Max./Min. code length: Refer to [Max./Min. code length](#) of [3-15 Code 39 \(Code 32, Trioptic Code 39\)](#).

Code ID setting: Refer to [Code ID setting](#) of [3-10 UPC-A](#).

Insertion group selection: Refer to [Insertion group selection](#) of [3-10 UPC-A](#).



%SETUP SETUP

Option bar code	Option	Alpha. entry	Single-scan setting
Read 2301	Disable	00*	 %2301D00%
	Enable	01	 %2301D01%
Check digit verification 2302	Disable	00*	 %2302D00%
	1 digit (Mod 10)	01	 %2302D01%
	2 digits (Mod 10/10)	02	 %2302D02%
	2 digits (Mod 10/11)	03	 %2302D03%
Check digit transmission 2303	Disable	00*	 %2303D00%
	Enable	01	 %2303D01%
Max. code length 2304	00-99	00-99	
		00*	 %2304D00%
Min. code length 2305	00-99	00-99	
		00*	 %2305D04%
Code ID setting 2306	00-FF ₁₆ (ASCII)	00-FF ₁₆	
		<O>*	 %2306H4F%
Insert group selection 2307	00-44	00-44	
		00*	 %2307D00%
Reserved 2308			



%%END END

3-26 UK/Plessey

Read:

Format

Data digits (variable)	2 check digits (optional)
------------------------	---------------------------

Check digit verification: The UK/Plessey has one or two optional check digits. The check digit 1 and check digit 2 will be calculated as the sum module 10 or 11 of the data digits.

Check digit transmission: By setting Enable, check digit will be transmitted.



















Max./Min. code length: Refer to [Max./Min. code length](#) of [3-15 Code 39 \(Code 32, Trioptic Code 39\)](#).

Code ID setting: Refer to [Code ID setting](#) of [3-10 UPC-A](#).

Insertion group selection: Refer to [Insertion group selection](#) of [3-10 UPC-A](#).



%SETUP SETUP

Option bar code	Option	Alpha. entry	Single-scan setting
Read  2401	Disable	00*	 %2401D00%
	Enable	01	 %2401D01%
Check digit verification  2402	Disable	00	 %2402D00%
	Enable	01*	 %2402D01%
Check digit transmission  2403	Disable	00*	 %2403D00%
	Enable	01	 %2403D01%
Max. code length  2404	00-99	00-99	
		00*	 %2404D00%
Min. code length  2405	00-99	00-99	
		01*	 %2405D01%
Code ID setting  2406	00-FF ₁₆ (ASCII)	00-FF ₁₆	
		<U>*	 %2406H55%
Insert group selection  2407	00-44	00-44	
		00*	 %2407D00%
Reserved  2408			



%%END END

3-27 China Post

Read:

Format

11 Data digits

Max. /Min. code length: Refer to [Max./Min. code length](#) of [3-15 Code 39 \(Code 32, Trioptic Code 39\)](#).

The code length of China Post is 11.

Code ID setting: Refer to [Code ID setting](#) of [3-10 UPC-A](#).

Insertion group selection: Refer to [Insertion group selection](#) of [3-10 UPC-A](#).



%SETUP SETUP

Option bar code	Option	Alpha. entry	Single-scan setting
Read 2601	Disable	00	 %2601D00%
	Enable	01*	 %2601D01%
Reserved 2602			
Reserved 2603			
Max. code length 2604	00-99	00-99	
		11*	 %2604D11%
Min. code length 2605	00-99	00-99	
		11*	 %2605D11%
Code ID setting 2606	00-FF ₁₆ (ASCII)	00-FF ₁₆	
		<T>*	 %2606H54%
Insert group selection 2607	00-44	00-44	
		00*	 %2607D00%
Reserved 2608			



%%%END END

3-28 China Finance

Note: This type of barcode is not Omni-directionally decodable. The encodable character set includes numeric 0 to 9. Among the symbol of 0 to 9, 0 and 2, 4 and 9, 5 and 8, 6 and 7, have the symmetrical pattern; the pattern of 1 and 3 is symmetrical.

Read:

Format

10 Data digits

Max./Min. code length: Refer to [Max./Min. code length](#) of [3-15 Code 39 \(Code 32, Trioptic Code 39\)](#).

Check digit verification: The check digit is made as the sum module 10 of the numerical values of all data digits.

Leading character 5/6/7/8/9 converted to A/B/C/D/E: By setting, leading character 5/6/7/8/9 can be converted to A/B/C/D/E.

Leading character assignment: By setting, only the barcode with the assigned leading character can be output.

Code ID setting: Refer to [Code ID setting](#) of [3-10 UPC-A](#).

Insertion group selection: Refer to [Insertion group selection](#) of [3-10 UPC-A](#).



%SETUP SETUP

Option bar code	Option	Alpha. entry	Single-scan setting
Read 3201	Disable	00	 %3201D00%
	Enable	01*	 %3201D01%
Max. code length 3202	00-99	00-99	
		10*	 %3202D10%
Min. code length 3203	00-99	00-99	
		10*	 %3203D10%
Check digit verification 3204	Disable	00*	 %3204D00%
	Reserved	01	 %3204D01%
Leading character 5/6/7/8/9 converted to A/B/C/D/E 3205	Disable	00	 %3205D00%
	Enable	01*	 %3205D01%
	Only 5 converted to A	02	 %3205D02%
	Only 6 converted to B	03	 %3205D03%
	Only 7 converted to C	04	 %3205D04%
	Only 8 converted to D	05	 %3205D05%
	Only 9 converted to E	06	 %3205D06%
Leading character assignment 3206	Disable	00	 %3206D00%
	Assigned to 0	01*	 %3206D01%
	Assigned to 5(A)	02	 %3206D02%
	Assigned to 6(B)	03	 %3206D03%
	Assigned to 7(C)	04	 %3206D04%



%SETUP SETUP

Option bar code	Option	Alpha. entry	Single-scan setting
	Assigned to 8(D)	05	 %3206D05%
	Assigned to 9(E)	06	 %3206D06%
	Assigned to 1	07	 %3206D07%
	Assigned to 2	08	 %3206D08%
	Assigned to 3	09	 %3206D09%
	Assigned to 4	10	 %3206D10%
Code ID setting 3207	00-FF ₁₆ (ASCII)	00-FF ₁₆	
		<Y>*	 %3207H59%
Insert group selection 3208	00-44	00-44	
		00*	 %3208D00%



%%END END



%%LLDS

Laser Light Direction Setting: By scanning the barcode above, the decoding direction of the scanner's laser light is from left to right. By scanning the up-side-down barcode above, the decoding direction of the scanner's laser light is from right to left.

3-29 Telepen

Read:

Format

Start character ()	Data digits (variable)	Check digit	End character (z)
---------------------	------------------------	-------------	-------------------

Check digit verification: The check digit verification is optional.

Check digit transmission: By setting Enable, check digit will be transmitted.

Max./Min. code length: Refer to [Max./Min. code length](#) of [3-15 Code 39 \(Code 32, Trioptic Code 39\)](#).

Code ID setting: Refer to [Code ID setting](#) of [3-10 UPC-A](#).

Insertion group selection: Refer to [Insertion group selection](#) of [3-10 UPC-A](#).

Encode character set type: Two options. Same Telepen symbol, with different option, is associated with different data output.



















Alphanumeric- Supports both letters and numbers within the data source.

Numeric- Supports only numbers within the data source and ignores all letters.



%SETUP

SETUP

Multiple-scan setting			Single-scan setting
Option barcode	Option	Alpha. entry	
Read  3501	Disable	00	 %3501D00%
	Enable	01*	 %3501D01% *
Check digit verification  3502	Disable	00	 %3502D00%
	Enable	01*	 %3502D01% *
Check digit transmission  3503	Disable	00*	 %3503D00% *
	Enable	01	 %3503D01%
Max. code length  3504	00-99	00-99	
		00*	 %3504D00% *
Min. code length  3505	00-99	00-99	
		01*	 %3505D01% *
Code ID setting  3506	00-FF ₁₆	00-FF ₁₆	
		P*	 %3506H50% *
Insertion group selection  3507	00-66	00-66	
		00*	 %3507D00% *
Encode character set type  3508	Alphanumeric	00*	 %3508D00% *
	Numeric	01	 %3508D01%



%%%END

END

3-30 GS1 DataBar (GS1 DataBar Truncated)

GS1 DataBar Truncated is structured and encoded the same as the standard GS1 DataBar format, except its height is reduced to a 13 modules minimum; while GS1 DataBar should have a height greater than or equal to 33 modules.

Read:

Format

16 Data digits

Code ID setting: Refer to Code ID setting of [3-10 UPC-A](#).

Insertion group selection: Refer to Insertion group selection of [3-10 UPC-A](#).

Conversion:

UCC/EAN 128- Refer to Code ID transmission of [3-35 String transmission](#),]Cm will be identified as AIM ID.

UPC-A or EAN-13- Barcode beginning with a single zero as the first digit has the leading “010” stripped and the barcode reported as EAN-13. Barcode beginning with two or more zeros but not six zeros has the leading “0100” stripped and the barcode reported as UPC-A.

Option bar code	Option	Alpha. entry	Single-scan setting
 %SETUP SETUP			
Read  2701	Disable	00	 %2701D00%
	Enable	01*	 %2701D01%
Code ID setting  2702	00-FF ₁₆ (ASCII)	00-FF ₁₆	
		<R >*	 %2702H52%
Insert group selection  2703	00-44	00-44	
		00*	 %2703D00%
Conversion  2704	None	00*	 %2704D00%
	UCC/EAN 128	01	 %2704D01%
	UPC-A or EAN-13	02	 %2704D02%
Reserved  2705			
 %%% END END			

3-31 GS1 DataBar Limited

Read:

Format

16 Data digits

Code ID setting: Refer to [Code ID setting](#) of [3-10 UPC-A](#).

Insertion group selection: Refer to [Insertion group selection](#) of [3-10 UPC-A](#).

Conversion: Refer to [Conversion](#) of [3-30 GS1 DataBar \(GS1 DataBar Truncated\)](#).



%SETUP SETUP

Option bar code	Option	Alpha. entry	Single-scan setting
Read 2801	Disable	00	 %2801D00%
	Enable	01*	 %2801D01%
Code ID setting 2802	00-FF ₁₆ (ASCII)	00-FF ₁₆	
		<R >*	 %2802H52%
Insert group selection 2803	00-44	00-44	
		00*	 %2803D00%
Conversion 2804	None	00*	 %2804D00%
	UCC/EAN 128	01	 %2804D01%
	UPC-A or EAN-13	02	 %2804D02%
Reserved 2805			



%%%END END

3-32 GS1 DataBar Expanded

Read:

Format

Code ID setting: Refer to of [3-10 UPC-A](#).

Insertion group selection: Refer to of [3-10 UPC-A](#).

Conversion:

UCC/EAN 128- Refer to of [3-35 String transmission](#),]Cm will be identified as AIM ID.



%SETUP SETUP

Option bar code	Option	Alpha. entry	Single-scan setting
Read 2901	Disable	00	 %2901D00%
	Enable	01*	 %2901D01%
Max. code length 2902	00-99	00-99	
		00*	 %2902D00%
Min. code length 2903	00-99	00-99	
		01*	 %2903D01%
Code ID setting 2904	00-FF ₁₆ (ASCII)	00-FF ₁₆	
		<R >*	 %2904H52%
Insert group selection 2905	00-44	00-44	
		00*	 %2905D00%
Conversion 2906	None	00*	 %2906D00%
	UCC/EAN 128	01	 %2906D01%
Reserved 2907			



%%%END END

3-33 G1-G4 & C1-C2 & FN1 substitution string setting

Format of barcode data transmission

Prefix	Code name	Preamble	Code ID	Code length	Code data	Code ID	Postamble	Suffix
--------	-----------	----------	---------	-------------	-----------	---------	-----------	--------

Suffix string setting: The <enter> key is represented in different ASCII when it is applied by different OS. For a Windows/DOS OS, <enter> is represented as <CR><LF> (0x0D 0x0A); for an Apple MAC OS, <enter> is represented as <CR> (0x0D); for a Linux/Unix OS, <enter> is represented as <LF> (0x0A).

Prefix/Suffix string setting & Preamble/Postamble string setting:

They are appended to the data automatically when a barcode is decoded.

Example: Add a symbol of "\$" as a prefix for all symbols.

Steps:

- 1) Scan **SETUP** and **Prefix string setting** barcode.
- 2) Use the ASCII table to find the value of \$→24.
- 3) Scan **2** and **4** from the barcode on the foldout back page.
- 4) Scan **END** barcode.

Scanning steps: Scan the following barcodes in order.



Insert G1/G2/G3/G4 string setting: The scanner offers 4 positions and 4 character strings to insert among the symbol.

Example: Set G1 string to be "AB".

Original code data	"1 2 3 4 5 6"
Output code data	"1 2 A B 3 4 5 6"

Steps:

- 1) Scan **SETUP** and **Insert G1 string setting** barcode "8005".
- 2) Use the ASCII table to find the value of A→41, B→42.
- 3) Scan **4**, **1** and **4**, **2** from the barcode on the foldout back page.
- 4) Scan **END** barcode.
- 5) Refer to the chapter of [3-34 G1-G4 string position & Code ID position](#).
- 6) Refer to the chapter of [3-7 Scan mode & some global settings](#).

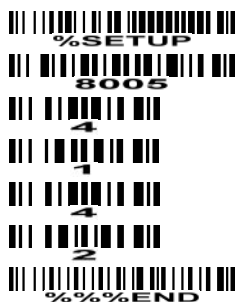

Testing barcode:



FN1 substitution string setting: The FN1 character (0x1D) in an UCC/EAN128 barcode, or a Code 128 barcode, or a GS1 DataBar barcode can be substituted with a defined string.

Truncate leading G5 string setting: By setting, a defined leading character or string can be truncated. Also a single character can be un-defined.

Repeat of a G5 character setting: While G5 is set as a single defined/un-defined character, G5 can

also be set to be repeated. This setting is ignored when the truncate number is more than the barcode data characters. The option of “FF” for this setting is not active while the option of Truncate leading G5 string setting is “00”.

Example: Truncate all leading zeros for all symbols.

Original code data	“0 0 0 1 2 3 4 5 6”
Output code data	“1 2 3 4 5 6”

Steps: scan the following data in order.



Testing barcode:



Truncate ending G4 string setting: By setting, a defined ending character or string can be truncated. Also a single character can be un-defined.

Repeat of a G4 character setting: While G5 is set as a single defined/un-defined character, G4 can also be set to be repeated. This setting is ignored when the truncate number is more than the barcode data characters. The option of “FF” for this setting is not active while the option of Truncate ending G4 string setting is “00”.

Single character C1/C2 replacement: By setting, a defined character in the data string can be replaced by another defined character. The C1 and C2 replacement are applied simultaneously.

Example: Replace all the “A” character in a data string to be “B” character.

Original code data	“1 2 3 A 5 A”
Output code data	“1 2 3 B 5 B”

Steps: scan the following barcodes in order. The ASCII value for “A” is 41, and the ASCII value for “B” is 42.

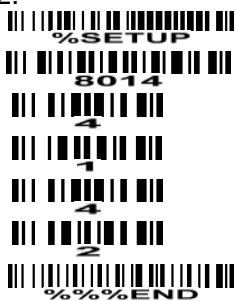



















Testing barcode:





%SETUP SETUP

Option bar code	Option	Alpha. entry	Single-scan setting
Prefix string setting  8001	0-22 characters	00-FF ₁₆	
	None	00*	 %8001H00%
Suffix string setting  8002	0-22 characters	00-FF ₁₆	
	<ENTER>	0D0A*	
Preamble string setting  8003	0-22 characters	00-FF ₁₆	
	None	00*	 %8003H00%
Postamble string setting  8004	0-22 characters	00-FF ₁₆	
	None	00*	 %8004H00%
Insert G1 string setting  8005	0-22 characters	00-FF ₁₆	
	None	00*	 %8005H00%
Insert G2 string setting  8006	0-22 characters	00-FF ₁₆	
	None	00*	 %8006H00%
Insert G3 string setting  8007	0-22 characters	00-FF ₁₆	
	None	00*	 %8007H00%
Insert G4 string setting  8008	0-22 characters	00-FF ₁₆	
	None	00*	 %8008H00%
FN1 substitution string setting  8009	0-4 characters	00-FF ₁₆	
	<SP>	20*	 %8009H20%
Truncate leading G5 string setting  8010	A un-defined character	00	 %8010H00%
	1-22 defined characters	01-7F ₁₆	



%SETUP SETUP

Option bar code	Option	Alpha. entry	Single-scan setting
	<0>	30*	 %8010H30%
Repeat of a G5 character setting 8011	Once	01*	 %8011H01%
	Defined times	01-22	
	Un-defined times (All)	FF	 %8011HFF%
Truncate ending G4 string setting 8012	A un-defined character	00	 %8012H00%
	1-22 defined characters	01-7F ₁₆	
	<0>	30*	 %8012H30%
Repeat of a G4 character setting 8013	Once	01*	 %8013H01%
	Defined times	01-22	
	Un-defined times (All)	FF	 %8013HFF%
Single character C1 replacement 8014	0000-FFFF ₁₆	0000*	
		0000-FFFF ₁₆	
Single character C2 replacement 8015	0000-FFFF ₁₆	0000*	
		0000-FFFF ₁₆	



%%%END END

3-34 G1-G4 string position & Code ID position

Format of barcode data transmission













Prefix	Code name	Preamble	Code ID	Code length	Code data	Code ID	Postamble	Suffix
--------	-----------	----------	---------	-------------	-----------	---------	-----------	--------

Insert G1/G2/G3/G4 string position: The scanner offers 4 positions to insert strings among the symbol. In case of the insertion position is greater than the length of the symbol, the insertion of string is not effective.

Code ID position: It is allowed to select different positions of code ID placement.



%SETUP SETUP

Option bar code	Option	Alpha. entry	Single-scan setting
Insert G1 string position  8101	00-99	00-99	
		00*	 %8101D00%
Insert G2 string position  8102	00-99	00-99	
		00*	 %8102D00%
Insert G3 string position  8103	00-99	00-99	
		00*	 %8103D00%
Insert G4 string position  8104	00-99	00-99	
		00*	 %8104D00%
Code ID position  8105	Before code data	00*	 %8105D00%
	After code data	01	 %8105D01%
Reserved  8106			
Reserved  8107			



%%%END END

3-35 String transmission

Note: The information in this chapter is closely related to the chapter of String setting.

Format of barcode data transmission

Prefix	Code name	Preamble	Code ID	Code length	Code data	Code ID	Postamble	Suffix
--------	-----------	----------	---------	-------------	-----------	---------	-----------	--------

Prefix transmission: By setting Enable, prefix will be appended before the data transmitted.

Suffix transmission: By setting Enable, suffix will be appended after the data is transmitted.

Code name transmission: By setting Enable, code name will be transmitted before code data.

Preamble transmission: By setting Enable, preamble will be appended before the data transmitted.

Postamble transmission: By setting Enable, postamble will be appended after the data is transmitted.

Code ID transmission: Code ID can be transmitted in the format of either Proprietary ID or AIM ID. Refer to the chapter of [1-2 Default setting for each barcode](#).

Code length transmission: The length of code data string can be transmitted before the code data when Enable is selected. The length is represented by a number with two digits.

Case conversion: The characters within code data or the whole output string can be set in either upper case or lower case.

FN1 substitution transmission: The scanner supports a FN1 substitution feature for keyboard wedge, USB and RS-232 interface. The replacement string of FN1 can be chosen by user (see chapter of [3-33 G1-G4 & C1-C2& FN1 substitution string setting](#)).





















All-non-printable-character string transmission with string setting: By setting enable, all string settings, e.g. [Preamble transmission](#) or [Insert G1 string setting](#), are active for an all-non-printable-character string. Here a non-printable character means a character with ASCII value between 0x00 to 0x1F.

Transmit the first N data characters only: The scanner supports to only transmit the first N data characters of a barcode. The number of N can be set as a digit between 1 and 99.

Transmit the last N data characters only: The scanner supports to only transmit the last N data characters of a barcode. The number of N can be set as a digit between 1 and 99.



%SETUP SETUP

Option bar code	Option	Alpha. entry	Single-scan setting
Prefix transmission  8201	Disable	00*	 %8201D00%
	Enable	01	 %8201D01%
Suffix transmission  8202	Disable	00	 %8202D00%
	Enable	01*	 %8202D01%
Code name transmission  8203	Disable	00*	 %8203D00%
	Enable	01	 %8203D01%
Preamble transmission  8204	Disable	00*	 %8204D00%
	Enable	01	 %8204D01%
Postamble transmission  8205	Disable	00*	 %8205D00%
	Enable	01	 %8205D01%
Code ID transmission  8206	Disable	00*	 %8206D00%
	Proprietary ID	01	 %8206D01%
	AIM ID	02	 %8206D02%
Code length transmission  8207	Disable	00*	 %8207D00%
	Enable	01	 %8207D01%
Case conversion  8208	Disable	00*	 %8208D00%
	Upper (data only)	01	 %8208D01%
	Lower (data only)	02	 %8208D02%
	Upper (whole string)	03	 %8208D03%
	Lower (whole string)	04	 %8208D04%



%SETUP SETUP

Option bar code	Option	Alpha. entry	Single-scan setting
FN1 substitution transmission  8209	Disable	00*	 %8209D00%
	Keyboard wedge/USB	01	 %8209D01%
	RS-232	02	 %8209D02%
	Keyboard wedge/ USB/RS-232	03	 %8209D03%
All-non-printable-character string transmission with string setting  8210	Disable	00*	 %8210D00%
	Enable	01	 %8210D01%
Transmit the first N data characters only  8211	All	99*	 %8211D99%
	01-99	01-99	
Transmit the last N data characters only  8212	All	99*	 %8212D99%
	01-99	01-99	



%%%END END

4 Troubleshooting

Problem	Possible causes	Possible solutions
Nothing happens when you follow the operating instructions, or the scanner displays erratic behavior.	No power to the scanner.	Check the system power. Ensure the power supply is connected.
	Incorrect cables.	Use the original cables.
	Connections are loose.	Check for loose cable connections.
Laser comes on, but the scanner does not decode.	Bar code symbol is unreadable.	Check the symbol to make sure it is not defaced. Try scanning test symbols of the same bar code type.
	Scanner is not programmed for the correct bar code type.	Be sure the scanner is programmed to read the type of bar code you are scanning.
	Distance between scanner and bar code is incorrect.	Move the scanner closer to or further from the bar code.
Scanned data is incorrectly displayed on the host.	Scanner is not programmed to work with the host. Check scanner host type parameters or editing options.	Be sure proper host is selected. For RS-232, ensure the scanner's communication parameters match the host's settings. For a USB-HID keyboard or a keyboard wedge configuration, ensure the system is programmed for the correct keyboard type and language, and the CAPS LOCK key is in the correct state.
Other circumstances.		Contact your distributor or the manufactory support centre.

5 Maintenance

Cleaning the exit window is the only maintenance required. A dirty window may affect scanning accuracy.

1. Do not allow any abrasive material to touch the window.
2. Remove any dirt particles with a damp cloth.
3. Wipe the window using a tissue moistened with water.
4. Do not spray water or other cleaning liquids directly into the window.
5. Use a piece of soft and dry cloth when cleaning the scanner.

6 Assembling the stand

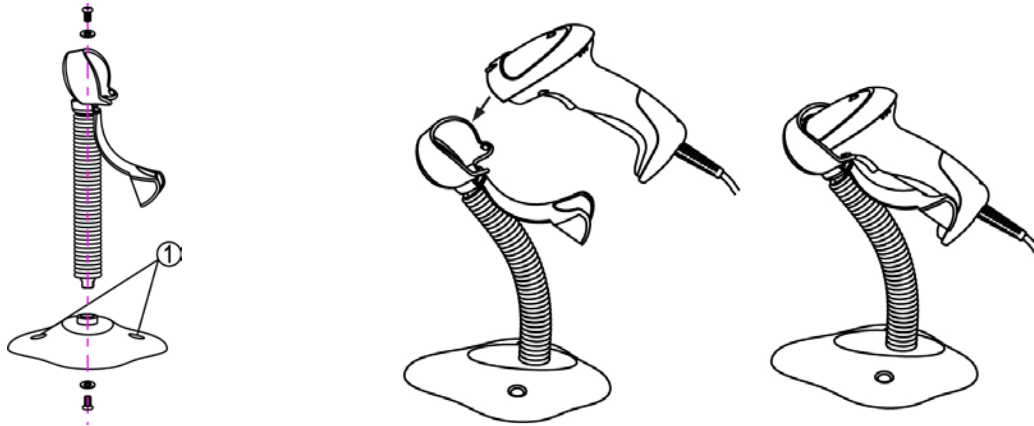

1. See the figure above, tighten the screws.
2. Bend the neck to the desired position for scanning.
3. Screw mounting: Screw one #10 wood screw into each screw-mount-hole until the base of the stand is secured.
4. Tape mounting: ①Peel the paper liner off one side of each piece of tape and place the sticky surface over each of the three rectangular tape holders. ②Peel the paper liner off the exposed sides of each piece of tape and press the stand on a flat surface until it is secure.

7 Barcode representing non-printable character

Notes to make the following barcode:

1. According to different barcode printing software, the method of printing following barcode is different.
2. If using CODESOFT software, firstly read the information through “Help→Index→Code128→Special input syntax”. Also refer to ASCII table. For example, if we wish to make “F1” barcode, select “code128”, then select “CODE A” type, and input “{DOC1}” as data.



Up ↑



Down ↓



Left ←



Right →



Page Up



Page Down



Backspace



Tab



Home



End



Enter



Insert



Delete



F1



F2



F3



F4



F5



F6



F7



F8



F9



F10



Esc



F11



F12

8 ASCII Table

		for keyboard wedge		for RS-232	
H L	0	1	0	1	
0	Null		NUL	DLE	
1	Up	F1	SOH	DC1	
2	Down	F2	STX	DC2	
3	Left	F3	ETX	DC3	
4	Right	F4	EOT	DC4	
5	PgUp	F5	ENQ	NAK	
6	PgDn	F6	ACK	SYN	
7		F7	BEL	ETB	
8	Bs	F8	BS	CAN	
9	Tab	F9	HT	EM	
A		F10	LF	SUB	
B	Home	Esc	VT	ESC	
C	End	F11	FF	FS	
D	Enter	F12	CR	GS	
E	Insert	Ctrl+	SO	RS	
F	Delete	Alt+	SI	US	

Notes: The 2nd and the 3rd columns above are used for keyboard wedge only.

H L	2	3	4	5	6	7
0	SP	0	@	P	`	p
1	!	1	A	Q	a	q
2	“	2	B	R	b	r
3	#	3	C	S	c	s
4	\$	4	D	T	d	t
5	%	5	E	U	e	u
6	&	6	F	V	f	v
7	‘	7	G	W	g	w
8	(8	H	X	h	x
9)	9	I	Y	i	y
A	*	:	J	Z	j	z
B	+	;	K	[k	{
C	,	<	L	\	l	
D	-	=	M]	m	}
E	.	>	N	^	n	~
F	/	?	O	_	o	DEL

Example: ASCII “A” = “41”.

9 Test Chart

UPC-A

6 59871 23231 9

UPC-E

0 232310 7

UPC-E1

1 6 5 4 3 2 1 4

EAN-13

1 234567 891019

ISBN/ISSN

9 780194 315104

EAN-8

0123 4510

Code 39

0189-+ \$AZ

Code 32

A908765439

Trioptic Code 39
(Default setting: Disable)

\$123456\$

Interleaved 2 of 5

0123456789

Industrial 2 of 5
(Default setting: Disable)

0123456789

Matrix 2 of 5

9876543210

Codabar

a01+-.:/ \$89a

Test chart (continue)

Code 128



01AZ[+~*/]za98

UCC/EAN 128



01AZ[]+~az54

ISBT 128



=1234 56789

Code 93



01AZ+~/*az89

Code 11

(Default setting: Disable)



123456789-0

MSI/Plessey

(Default setting: Disable)



0123456789

UK/Plessey



01ABEF89

China Post



54789632145

Telepen



_1234567z

GS1 DataBar (GS1 DataBar Truncated)



(01) 12345678901231

GS1 DataBar Limited



(01) 1 2345678 90126 2

GS1 DataBar Expanded



Ab_09+yZ

10 Return default parameters & Firmware version list



%%%DEF

WARNING: Default value initialization

If you wish to return the scanner to all the factory default settings, scan the barcode above.



%%%VER

Firmware version list

If you wish to display the firmware version, scan the barcode above.

11 Configuration alphanumeric entry barcode



0



2



4



6



8



A



C



E



1



3



5



7



9



B



D



F

To finish parameter setting, please scan the bar code below.



%%%END